

## Plow Bolts und Muttern / *Plow bolts and nuts* 12.9 Qualität / 10.9 Qualität

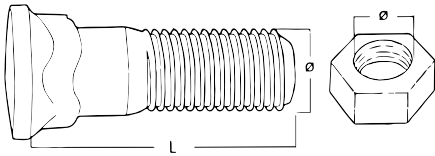



### Plow Bolts und Muttern

■ Aus warmgewalztem, hochverschleißfestem Borstahl, gehärtet auf ca. 500 HB

### *Plow bolts and nuts*

■ *Made of hot rolled Boron steel, hardened to approx. 500 HB*

L	Ø 5/8 "	Ø 3/4 "	Ø 7/8 "	Ø 1 "	Ø 1 - 1/4 "
	11 Thread "	10 Thread "	9 Thread "	8 Thread "	7 Thread "
	OEM-Ref.-Nr.	OEM-Ref.-Nr.	OEM-Ref.-Nr.	OEM-Ref.-Nr.	OEM-Ref.-Nr.
1 3/4 "	4F3653	-	-	-	-
2 "	4F3654	4F3672	-	-	-
2 1/4 "	3F5108	4F7827	-	-	-
2 1/2 "	4F3656	5J4773	5J4772	3J2801	-
2 3/4 "	4F3657	5J4771	6F0196	1J5607	-
3 "	4F3658	4F0138	5J2409	4F4042	-
3 1/4 "	-	-	8J2935	4J9058	8T9079
3 1/2 "	4F3665	34.3/4 x 3 1/2	2J2548	4J9208	-
3 3/4 "	-	5F8933	-	8J2928	6V6535
4 "	4F3671	34.3/4 x 4	34.7/8 x 4	5P8136	-
4 1/8 "	-	-	-	1J3527	5P8823
4 1/2 "	-	-	-	-	6V8360
5 "	-	-	-	-	5P8361

	4K0367	2J3506	2J3505	2J3507	3K9770
	34.5/8FE	34.3/4FE	34.7/8FE	34.1FE	-
	5P8247	5P8248	5P8249	5P8250	4K0684

## Sechskantschrauben Hexagonal fasteners 10.9 Qualität

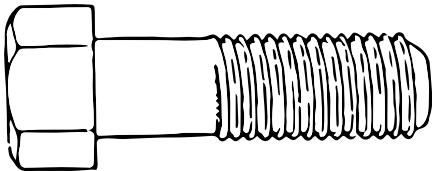

L (mm)	Ø M 12	Ø M 14	Ø M 16	Ø M 18	Ø M 20	Ø M 24	Ø M 30
40	-	-	-	-	M20x40	-	-
45	M12x45	-	M16x45	-	-	-	-
50	-	M14x50	M16x50	-	M20 x50	-	-
55	M12x55	-	-	-	-	-	M30x100
60	-	M14x60	M16x60	-	M20x60	-	-
65	M12x65	-	-	M18x80	-	-	M30x120
70	-	-	M16x70	-	M20x70	M24x70	-
80	-	-	M16x80	-	M20x80	M24x80	M30x140
90	-	-	-	-	M20x90	M24x90	M30x150
100	-	-	-	-	-	M24x100	M30x180
110	-	-	-	-	-	M24x110	M30x200
120	-	-	-	-	-	M24x120	-
130	-	-	-	-	-	M24x130	-
140	-	-	-	-	-	M24x140	-
150	-	-	-	-	-	M24x150	-
180	-	-	-	-	-	M24x180	-
200	-	-	-	-	-	M24x200	-

### Senkschrauben mit Innensechskant DIN 7991

Coarse metric thread 10.9 Qualität

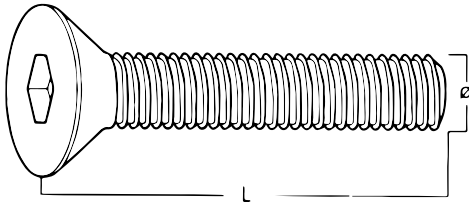

L (mm)	Ø M 12	Ø M 14	Ø M 16	Ø M 18	Ø M 20	Ø M 24	Ø M 30
40	M12x40SI	-	-	-	M20x40 SI	-	-
45	M12x45SI	-	M16x45SI	-	-	-	-
50	M12x50SI	-	M16x50SI	-	M20x50SI	-	-
55	-	M14x55SI	M16x55SI	-	M20x55SI	-	-
60	M12x60SI	-	M16x60SI	M18x60SI	M20x60SI	M24x60SI	-
70	-	-	M16x70SI	-	M20x70SI	M24x70SI	-
80	-	-	M16x80SI	M18x80SI	M20x80SI	M24x80SI	M30x80SI
90	-	-	-	-	M20x90SI	M24x90 SI	M30x90SI
100	-	-	-	-	M20x100SI	M24x100SI	M30x100SI
110	-	-	-	-	-	M24x110 SI	-
120	-	-	-	-	M20x120SI	M24x120 SI	-
130	-	-	-	-	-	-	M30x130SI

### Hexagonal-Muttern DIN 934/DIN 980, metrisches Gewinde

Hexagonal nuts 10.9 Qualität

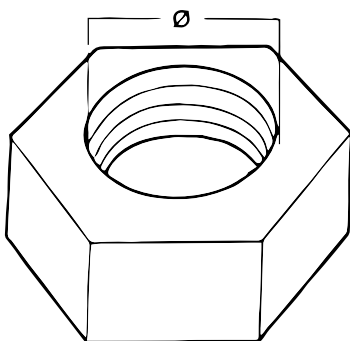

DIN 934
Ø
M 12
M 14
M 16
M 18
M 20
M 22
M 24
M 30

DIN 980
Ø
-
-
M 16
M 18
M 20
-
M 24
M 30