

## Schraubzähne / Bolt-on teeth

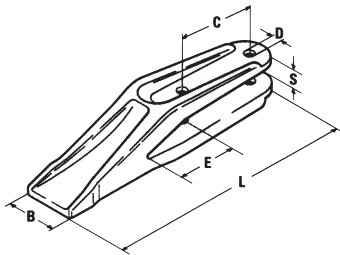

### Gabelschraubzähne

- Aus hochverschleißfestem Stahl
- Geeignet für Schneiden von etwa 15 bis 40 mm
- Mit spitzem Schlitz

### Fork type teeth

- Made of highly wear resistant steel
- Suitable for cutting edge from 15-40 mm
- Slot accepts chamfered edges

Abmessungen (mm) Dimensions (mm)						Gewicht Weight KG	Ref.-Nr. Ref.-No.	VeRotool-Bestell-Nr VeRotool-No.		
B	C	D	E	L	S			Zahn Tooth	Schrauben* Bolts*	Anzahl Quantity
60	65	12	65	275	21	3,3	8282253 O&K	209	M 12 x 55	2
80	110	17	75	360	26	4,9	771956709 Hanomag	201	M 16 x 70	2
85	135	17	90	420	34	9,7	777956706 Hanomag	202	M 16 x 80	2

\*gehören nicht zum Lieferumfang / do not belong to scope of supply

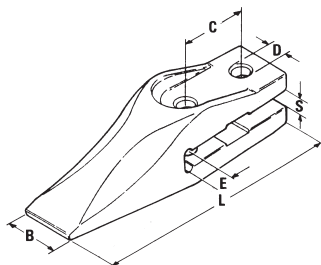

### Gabelschraubzähne

- Aus hochverschleißfestem Stahl
- Mit stumpfem Schlitz

### Fork type teeth

- Made of highly wear resistant steel
- Slot accepts flat edges

Abmessungen (mm) Dimensions (mm)						Gewicht Weight KG	Ref.-Nr. Ref.-No.	VeRotool-Bestell-Nr VeRotool-No.		
B	C	D	E	L	S			Zahn Tooth	Schrauben* Bolts*	Anzahl Quantity
39	55	17	35	210	17	2,0	68131-6691-2 Kubota	217	M 16 x 45	2

\*gehören nicht zum Lieferumfang / do not belong to scope of supply

## Schraubzähne / Bolt-on teeth

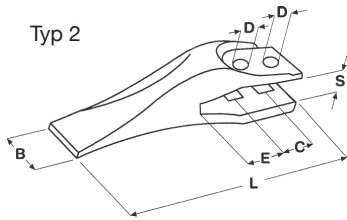
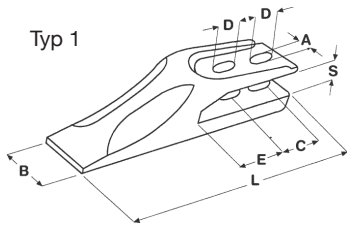

### Gabelschraubzähne

- Aus hochverschleißfestem Stahl
- Geeignet für Schneiden von 15 bis 21 mm
- Mit spitzem Schlitz

### Fork type teeth

- Made of highly wear resistant steel
- Suitable for cutting edge from 15-21 mm
- Slot accepts chamfered edges

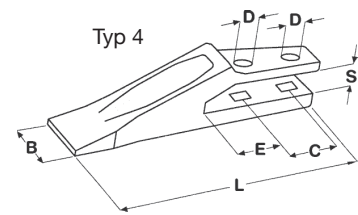
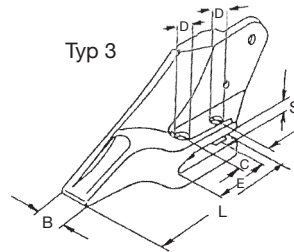

Abmessungen (mm) Dimensions (mm)							Typ Type	Gewicht Weight KG	Ref.-Nr. Ref.-No.	VeRotool-Bestell-Nr VeRotool-No.		
A	B	C	D	E	L	S				Zahn Tooth	Schrauben* Bolts*	Anzahl Quantity
13	42	40/45	18,0	36	185	17	1	1,2	6696, E12.4, SF100	204-2	M 12 x 45 SK	2
	45	45	13,0	40	190	15	2	1,2	825011090; E11.5	205-1	M 12 x 45 SK	2
	50	45	20,5	55	250	22	2	2,3	53103205-JCB	R17031100	3/4" x 2 3/4" PB	2
	50	45	20,5	55	280	22	3	2,6	53103208-JCB	R17031108	3/4" x 2 3/4" PB	2
	50	45	20,5	55	280	22	3	2,6	53103209-JCB	R17031109	3/4" x 2 3/4" PB	2
	50	75	20,0	50	280	22	4	2,6	6Y6335/9W1879-CAT	R17000100	5/8" x 2 1/2" PB	2

\*gehören nicht zum Lieferumfang / do not belong to scope of supply

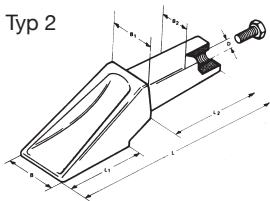
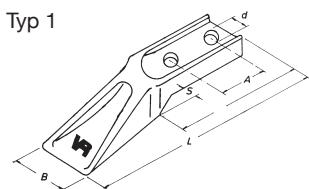

### Anschraub- und Anschweißzähne

- Geeignet für Schneidmesser von 15 bis 20 mm

### Bolt-on monobloc teeth

- Suitable for cutting edge from 15-20 mm

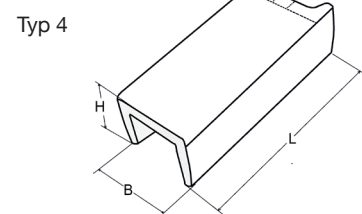
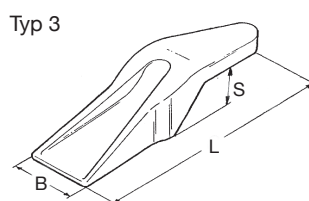

Typ Type	Abmessungen (mm) Dimensions (mm)							Gewicht Weight KG	Ref.-Nr. Ref.-No.	VeRotool-Bestell-Nr VeRotool-No.		
	A	B	C	D1	D2	L	S			Zahn Tooth	Schrauben* Bolts*	Anzahl Quantity
1	40/45	50	40	13	13	180	15	1,1	5902647350 Schaeff	91-2	M 12 x 40 SI	2
1	55/60	60	43	17	17	210	20	1,5	5902647360 Schaeff	94-2	M 16 x 45 SI	2
2	-	60	27	15	15	220	20	1,5	830899 Atlas	101	inklusive	-
3	-	50	-	-	-	180	16	0,9	6638	6638.214	-	-
4	-	50	-	-	-	120	-	1,0	830902	6653.157	-	-

\*gehören nicht zum Lieferumfang / do not belong to scope of supply

## Greiferzähne / Clam shell teeth

### Greifer-Schraubzähne

■ Aus hochverschleißfestem Stahl

### Clam-shell bolt-on teeth

■ Made of highly wear resistant steel

Typ 1

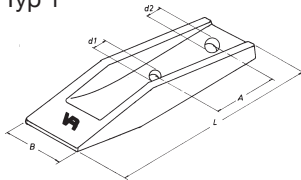

Typ 2

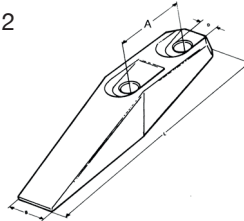

Typ 4

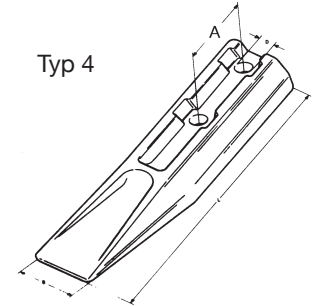

Typ Type	Abmessungen (mm) Dimensions (mm)					Gewicht Weight KG	Ref.-Nr. Ref.-No.	VeRotool-Bestell-Nr VeRotool-No.		
	A	B	D1	D2	L			Zahn Tooth	Schrauben* Bolts*	Anzahl Quantity
1	68	62	17	17	175	1,2	640002086	8656.210	M 16 x 45 SI	2
1	68	62	16	18	209	1,5	6383324056	8657.210	M 16 x 45 SI	2
1	85	62	17	17	209	1,5	640000050	8657.216	M 16 x 45 SI	2
2	100	50	25	26	315	4,9	1146761 - 33016	80	M 24 x 70 + 24 x 80 SK	je 1
2	110	60	25	26	405	7,5	307000287 - 300260021	81	M 24 x 90 + 24 x 80 SK	je 1
4	90	75	24	24	328	5,5	456113	200	M24 x 80 SK	2

\*gehören nicht zum Lieferumfang / do not belong to scope of supply

Typ 3

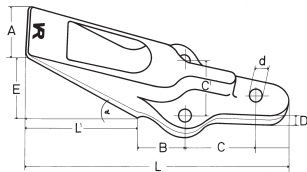

### Greifer-Schraubzähne

■ Aus hochverschleißfestem Stahl

### Clam-shell bolt-on teeth

■ Made of highly wear resistant steel

Typ Type	Abmessungen (mm) Dimensions (mm)										Gewicht Weight KG	Ref.-Nr. Ref.-No.	VeRotool-Bestell-Nr VeRotool-No.
	A	B	C	C1	D	E	L	L1	a	d			Zahn Tooth
3	68	40	78	60	16	53	265	126	21°	21	3,0	1153904 Atlas	6586.70-1
3	65	40	78	60	16	53	280	122	21°	17	3,0	0829589 Atlas	6586.70
3	75	65	90	70	20	61	328	125	24°	21	5,3	1218797 Atlas	6587.72
3	75	40	140	80	20	61	328	125	24°	18	5,3	9169430 Liebherr	6587.73
3	75	40	140	80	20	61	328	125	24°	21	5,3		6587.73-1